

## MEMS Capacitive Accelerometer



# ASC 4311LN / ASC 4315LN

- ▶ Uniaxial
- ▶ Ultra Low Noise (LN)
- ▶ High g-Range
- ▶ 4 Wire System
- ▶ Amplified Output
- ▶ Aluminium Housing / Stainless Steel Housing
- ▶ Made in Germany

### Features

- ▶ Range:  $\pm 2g$  to  $\pm 400g$
- ▶ DC Response
- ▶ High Shock Resistance
- ▶ Gas Damped
- ▶ Excellent Bias and Scale Factor Stability
- ▶ Differential Mode

### Options

- ▶ Customised Cable Length
- ▶ Customised Connector
- ▶ TEDS Module

### Applications

- ▶ Structural Monitoring and Testing
- ▶ Endurance Testing
- ▶ Brake Test
- ▶ Vibration Monitoring
- ▶ Civil Engineering
- ▶ Modal Analysis
- ▶ Vehicle Testing
- ▶ Automotive Ride Quality & Comfort
- ▶ Railway Engineering
- ▶ Flutter Test



## Capacitive MEMS Technology

The accelerometers are based on a capacitive MEMS technology and can be used in a low frequency response up from 0Hz. Inside the sensor element, the seismic mass is connected with two conductive capacitor plates. If the seismic mass oscillates between the two capacitor plates the capacitance will change. This capacitance change is converted via an ASIC (Application Specific Integrated Circuit) into an analog signal.

## Description

The model ASC 4311LN is an uniaxial accelerometer based on capacitive technology. It is over a wide temperature range fully compensated and factory calibrated. The sensor has been developed specifically for measuring relatively small accelerations, as required in the aerospace or automotive sector, for example.

Because capacitive technology is used, extremely small measuring ranges are possible. The amplified output is easy to use with a data acquisition unit. The signal is independent from the power between +8VDC to +30VDC. The package is hard anodized aluminium that is rugged for automotive, industrial and military applications.

A very high flexible rugged cable provides a simple mounting. The ASC 4311LN is equipped as standard with 6m cable. It is a Low Noise version and has a better frequency response. Owing to the lower noise the ASC 4311LN provides a higher resolution.

The stainless steel package of the ASC 4315LN provides a high resistance to strong environmental influences.

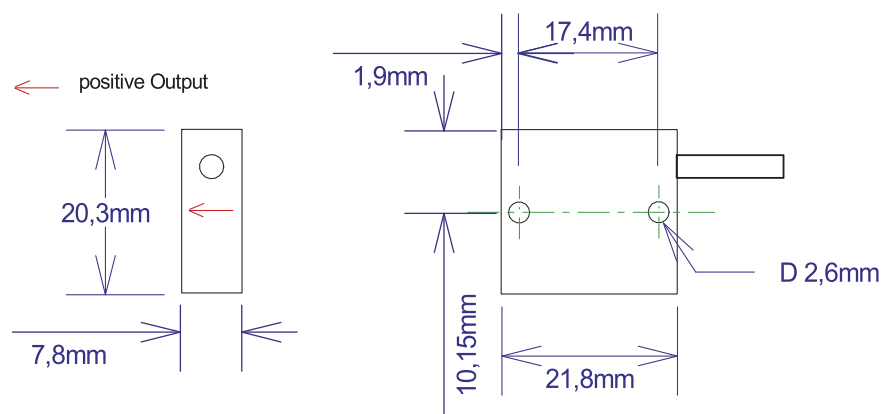

## Typical Specifications

### DYNAMIC

		Range ( $\pm$ g)							
		2	5	10	25	50	100	200	400
Sensitivity	mV/g	2000	800	400	160	80	40	20	10
Frequency response: $\pm$ 5%	Hz	100	100	300	500	650	650	1000	1000
Amplitude non-linearity	% FSO	<1							
Transverse sensitivity	%	3							
Shock limit	$\pm$ g	2000	2000	4000	4000	4000	4000	4000	4000
Recovery time	ms	<1							

### ELECTRICAL

Excitation voltage	V DC	8-30							
Supply current	mA	10							
Zero acceleration output	$\pm$ mV	150	150	80	80	80	80	80	80
Output Impedance	$\Omega$	100							
Isolation		Case Isolated							
Spectral noise	$\mu$ g/ $\sqrt$ Hz	5	7	10	25	50	100	200	400
Residual / Broadband noise ( $\pm$ 5% frequency range)	$\mu$ V	100	60	70	90	100	100	125	125

### ENVIRONMENTAL

Thermal sensitivity shift	%/ $^{\circ}$ C	0.015							
Thermal zero shift	mg/ $^{\circ}$ C	0.15	0.4	0.75	2	4	7.5	15	30
Operating temperature range	$^{\circ}$ C	-40 $^{\circ}$ C to +100 $^{\circ}$ C							
Storage temperature range	$^{\circ}$ C	-55 $^{\circ}$ C to +125 $^{\circ}$ C							
Humidity/Sealing		Epoxy sealed							

### PHYSICAL

Sensing element		MEMS Capacitive							
Case material		Aluminium/Stainless Steel							
Connector (at cable end)		Optional							
Mounting		Adhesive / screw holes							
Weight (without cable)	gram	ASC 4311LN: 7 gram ASC 4315LN: 19 gram							
Cable		12 gram/meter; AWG 30, Polyurethane (PUR); Diameter: 3mm							

**FACTORY CALIBRATION (SUPPLIED WITH THE SENSOR)**

Range	2g and 5g	10g	25g	50g and 100g	200g and 400g
Sensitivity	at 16Hz and 0.5g	at 80Hz and 5g	at 80Hz and 15g	at 80Hz and 20g	at 80Hz and 20g
Frequency Response	1 to 100Hz	10 to 300Hz	10 to 500Hz	10 to 650Hz	10 to 1000Hz

**CALIBRATION DIN ISO 17025 (ORDER SEPARATELY)**

Range	2g and 5g	10g	25g	50g and 100g	200g and 400g
Sensitivity	at 16Hz and 0.5g	at 80Hz and 5g	at 80Hz and 5g	at 80Hz and 20g	at 80Hz and 20g
Frequency Response	0.5 to 150Hz	10 to 500Hz	10 to 800Hz	10 to 1600Hz	10 to 2000Hz

**Cable Code/Pin Configuration***Red*    *Supply +**Black*    *Supply -**Green*    *Signal +**White*    *Signal -***ORDERING INFORMATION**

ASC	4311LN	002	6	A
	Model number	Range (Ex. 050 is 50g)	Cable length (meters)	Connector & Pinout
				A: no connector

**ASC GmbH · Advanced Sensors Calibration**

Ledererstraße 10 · 85276 Pfaffenhofen · Germany · Tel. +49 (0) 8441 786 547 -0 · office@asc-sensors.de

All data, information, statements, photographs and graphic illustrations made in this data sheet are without any obligation and raise no liabilities to or form part of any sales contracts of ASC GmbH or any affiliates for components referred to herein.  
 © ASC GmbH 2011. All rights reserved. No part of this copyrighted work may be reproduced, modified or distributed in any form or by any means, or stored in any database or retrieval system, without the prior written permission of ASC GmbH or its affiliates. Any such unauthorized use for any purpose is a violation of the relevant copyright laws. Revision Jun2017

